

ELECTROGENICS LABS



AUSTRALIAN  
TECHNOLOGIES  
COMPETITION  
WINNER 2020

## ELECTROGENICS LABORATORIES LTD

(ACN 635 525 745)



The future of Semiconductors

# MOSkin™

Custom in-vivo  
radiation dosimetry

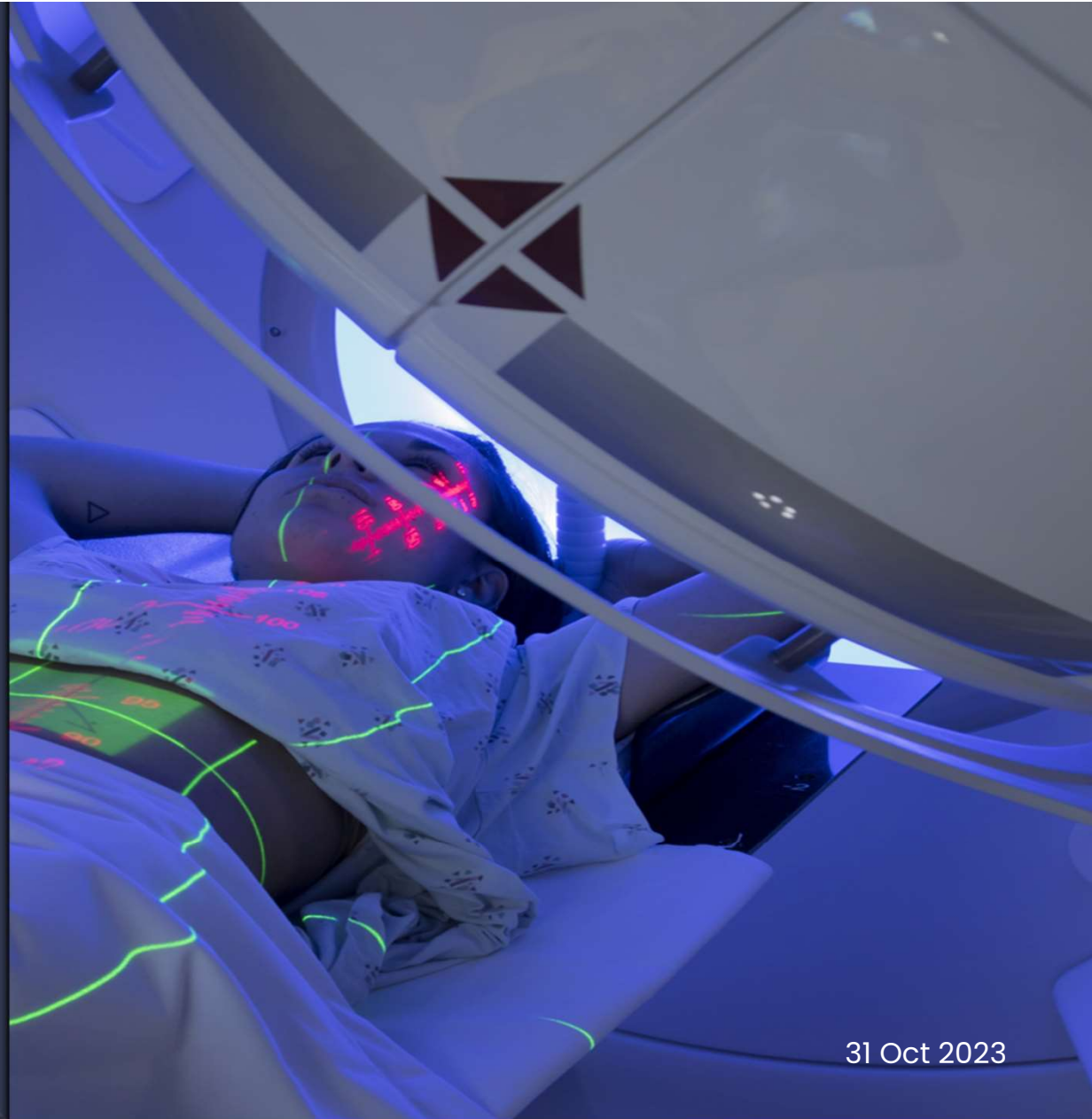

31 Oct 2023

# Background

- MOSkin™ is a real time solid state radiation dosimeter developed by Prof. Rosenfeld and his team at the Centre for Medical Radiation Physics at University of Wollongong
- Custom radiation sensitive p-channel MOSFET with novel packaging technology
- Patented in 80% of global markets
- Successful trials conducted at >20 International and Australian based Radiation Oncology Hospitals.
- ElectroGenics Laboratories Ltd (ELL) negotiated an exclusive license to commercialise the technology

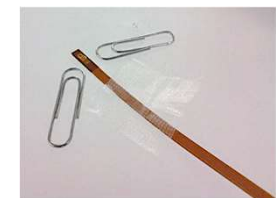
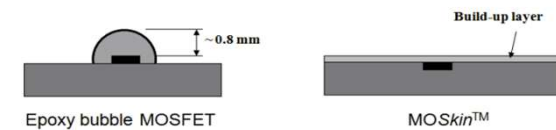
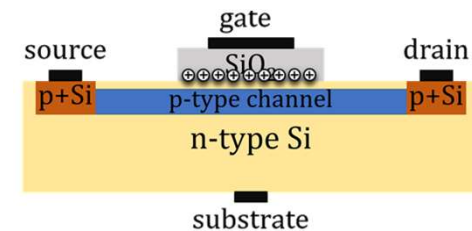



## Patents

APPLIED COUNTRY	TITLE OF INTELLECTUAL PROPERTY	PATENT NUMBER	FILING DATE	GRANT DATE	EXPIRY DATE
US	"Radiation Sensor and Dosimeter"	12/602,195; US8742357 (B2)	2 June 2008	3 June 2014	12 September 2031
China	"Radiation Sensor and Dosimeter"	CN101730853(A) CN101730853 (B)	2 June 2008	5 December 2012	2 June 2028
Europe	"Radiation Sensor and Dosimeter"	EP2150839(A1) EP2150839 (A4)	2 June 2008	5 August 2020	2 June 2028
International	"Radiation Sensor and Dosimeter"	WO2008148150 (A1) titled	2 June 2008	Filed	

- 2 key claims
  - A radiation sensor, comprising: a carrier material mountable to a substrate; and a semiconductor detector mounted to said carrier material; wherein a radiation sensitive portion of said semiconductor detector is oriented towards said carrier material and generally away from said substrate, and said carrier material is adapted to transmit radiation to said radiation sensitive portion of said semiconductor detector.
  - A method for thermo-stabilizing a semiconductor detector, comprising correcting threshold voltage drift arising owing to temperature changes according to the forward drop voltage of the source-substrate p-n junction
  
- In layman terms
  - **Sensor mounted upside down such that radiation passes through the polyimide (Accurate skin depth)**
  - **Correcting for temperature drift using the actual MOSFET (no need for additional temp compensation component on sensor)**

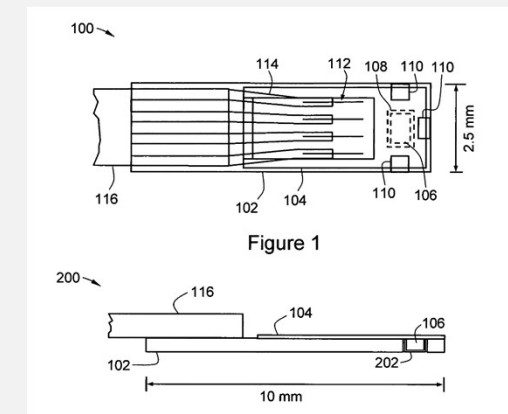

# MOSkin™ Technology Tested and Proven

CENTRE FOR  
MEDICAL  
RADIATION  
PHYSICS

UNIVERSITY  
OF WOLLONGONG  
AUSTRALIA



- MOSkin™ has been **tested and validated** in Australia and internationally in >20 hospitals and clinics
- Tested on **over 2,000** patients and simulations
- Over **40 published** scientific papers
- A subject of **21 PhDs**
- Over **\$10 million** in equity, cash and grants invested to date
- St George Public Radiation Oncology unit has been using the Company's prototypes under ethics committee approval for **over 12 months**, recently expressing interest to extend the use of prototypes in preference to existing in market technology

INTERNATIONAL	AUSTRALIA
Argon National Lab, USA	St George Cancer Care Centre, Prostate Cancer Institute, St George Hospital, Sydney
Mass General, Boston, USA	St Vincents Hospital, Sydney
Wisconsin University Hospital, USA	Liverpool Hospital
Brookhaven National Lab, USA	Calvary Mater Hospital – Newcastle, Australia
University of Malaya Medical Centre, Kuala Lumpur, Malaysia	Royal Adelaide Hospital
Italian National Institute of Tumours, Milan, Italy	Illawarra Cancer Care Centre
CERN Switzerland	Perth Hospital
KEK Japan	Prince of Wales Hospital
Sun Yat-Sen University Cancer Centre, Guangzhou China	Mater Hospital, Newcastle
Radiation Dosimetry Lab, Federal University of Pernambuco, Brazil	Peter MacCallum Cancer Centre
City University Hong Kong Hospital	Geneva Hospital

# Why It's CRITICAL To Monitor Medical Radiation Dose?



- Radiotherapy is recommended for over 50% of all cancer patients
  - Unwanted collateral organ or tissue damage is difficult to avoid
  - Human error was identified as the primary cause of reported incidents ( ARPANSA Report 2018 )
    - manual calculations,
    - time pressures, and
    - following procedures or treatment plans.
  - Overdosing or underdosing can lead to the reoccurrence of tumours or the development of secondary tumours
  - Flash therapy increases risks of unintended collateral damage
- CT scans and Interventional Radiology -
  - Up to equivalent of 200 chest X-rays

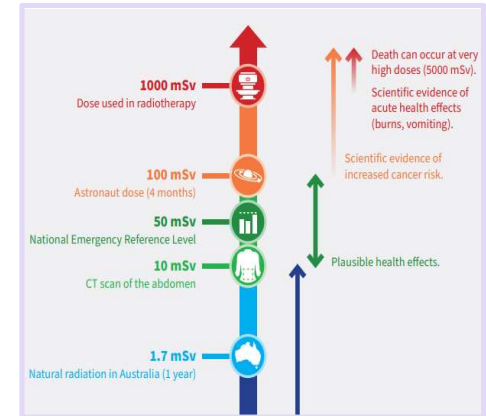

# Existing Dosimeters have many weaknesses



- **Very difficult and time consuming** to calibrate and use (1-2hrs)
  - **Do not all provide real time / immediate feedback** of delivered dose (e.g., Thermo-luminescent detectors (TLDs) > 1.5hrs)
  - **Do not measure the skin dose** at the international recommended standard (Water Equivalent Depth (WED) = 0.07mm)
  - **Are not single use** and therefore need to be cleaned / disinfected
  - **Are not radio transparent** - blocking Clinicians vision
  - **Are expensive & highly cumbersome** for routine use
- ... Limiting LINAC patient throughput, leading to reduced efficiency, increased wait times and suboptimal outcomes.**

## Existing OLD Technologies

**Diodes**

**TLDs**

**OSLDs**

**MOSFETs**

nanoDots are read directly in the microSTARii reader



# Dosimetry use is global & limited by time, complexity & costs



## Global radiotherapy customers

8,000 Radiotherapy Centres  
with 15,000 + Linear Accelerators (LINACs)

## Example dosimeter usage

### USA

- 9% of radiotherapy patients
- Key drivers
  - Safety in complex cases
  - ~US\$150 reimbursement
  - ~US\$1000 special physics consult

### France

- 19% of radiotherapy patients
- Key drivers
  - Mandated in regulation

LINAC Machines by Country

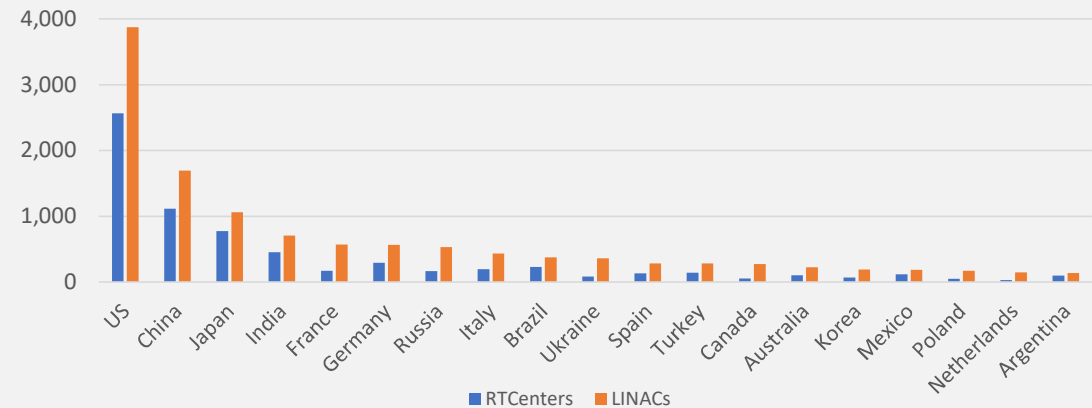

- Existing technologies have not materially changed in many years, wherein the use of dosimetry is therefore influenced and inhibited by the complexity, costs, and inadequacies of existing technologies.
- Because application of dosimetry is swayed by outdated wisdom and knowledge of old existing technologies, usage is stymied.
- ELL tunders its product is so cost and time effective, more accurate, with better clinical pathways ... its introduction will increase usage.

# Large Untapped Target Markets



## Cancer Patients Radio Oncology Therapy

- **20M** Global Cancer Patients per year
- **10M** Patients where radio oncology therapy indicated
- **6M** Patients with radio oncology therapy (avg. 15 fractions)
- **=90M** Treatments delivered per year



Dosimeters/year potential market  
(3 dosimeters average per procedure)

**TAM = 270M sensors**

## Interventional Radiology Procedures

- **40M+** Interventional Radiology procedures performed globally per annum, including
  - Neuro Angiography
  - Cardio Angiography
  - Venous Conditions
  - Interventional oncology



Dosimeters per year potential market (3  
dosimeters average per procedure)

**TAM = 120M sensors**

**Total Available Market (TAM) is ~ 390M Sensors per year**



# Introducing the MOSkin™ system



## MOSkin™ Sensors

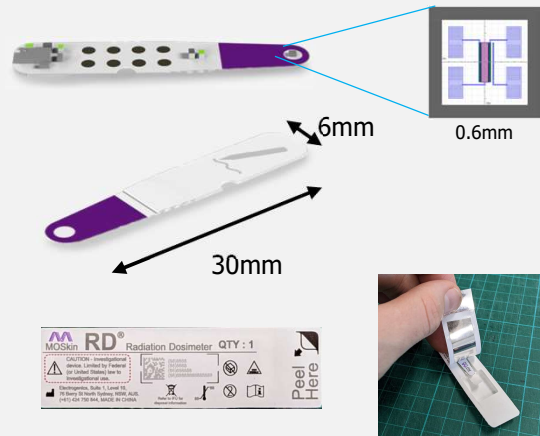

## Reusable build-ups



## MOSkin™ Hub

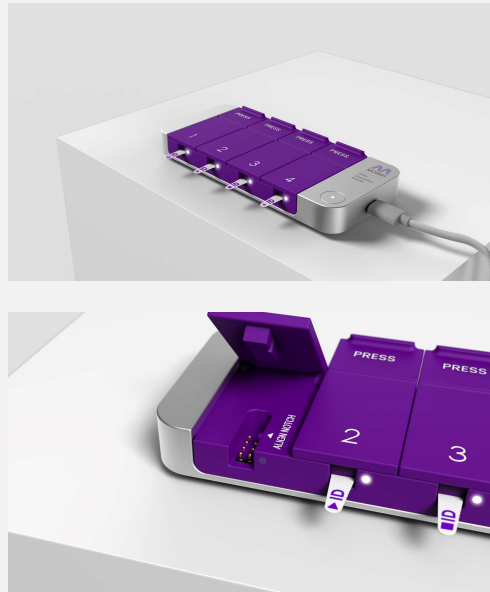

## MOSkin™ Reader



# Introducing the MOSkin™ system



## Existing Systems

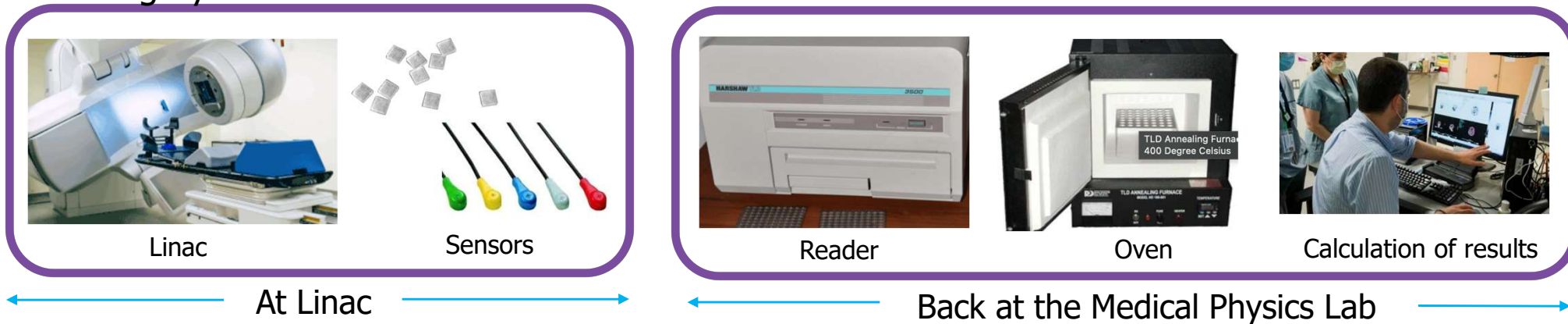

## MOSkin™ System



# Materially improving commercial & clinical pathways



Clinical Pathway for **Radiation Oncology** treatment **with existing Technology** per patient

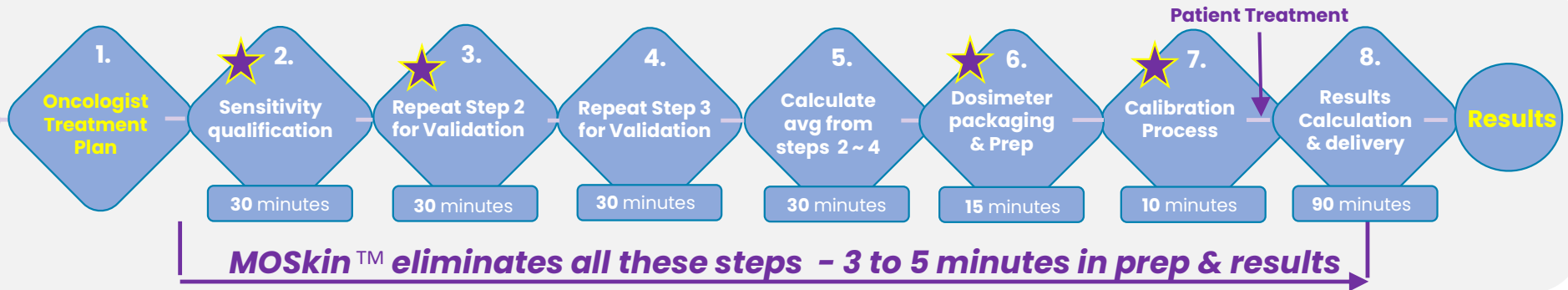

	\$ Capital Outlay	\$ Service cost~10yrs	\$ Cost for Sensors <sup>^</sup>	Prep time before Dose	Time to results	Max Patients /day/Linac #	Typical Accuracy	Application Coverage	Realtime	WED Std
Existing Technology <b>TLD Sensors</b>	\$50-\$250K	\$370K	\$30-\$60	2.4 hrs	>1.5 hrs	5~10	70~80%	~80%	NO	NO
Existing Technology <b>DIODES</b>	\$15- \$75K	\$112K	\$1.5-\$2.5K	1 hr	Real Time	12~15	75~85%	~70%	YES	NO
<b>MOSkin™</b>	\$7K	\$20K	\$35	3 mins*	Real time / Instant	20~25	95%+	99%+	YES	YES

<sup>^</sup> Per Sensor. Sensors can be used multiple fractions for same patient

\* Assumes pre-calibrated

# Linac = Linear accelerator, uses electricity to generate high energy beams of electrons

# RadFET sensor for total ionizing dose (TID) monitoring

## Illustration of main process in TID damage

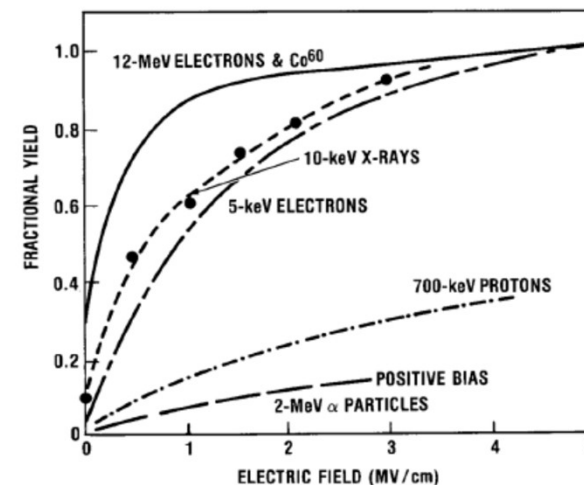
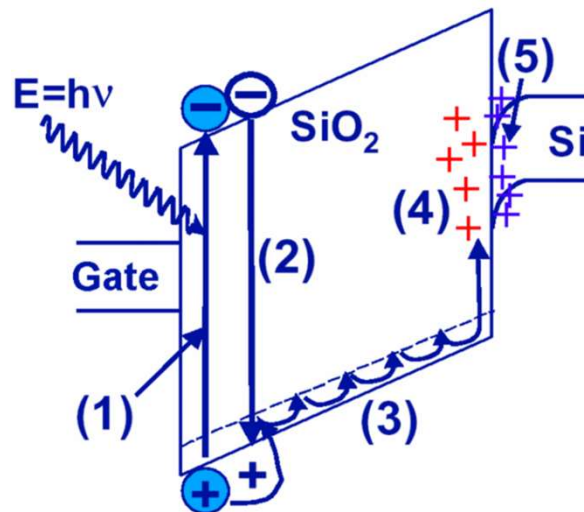
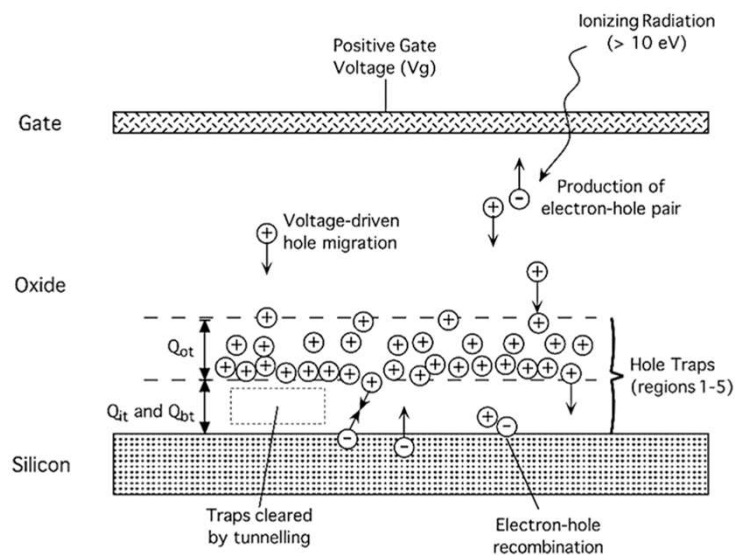

- (1) e-/h+ pair generation;
- (2) e-/h+ pair recombination;
- (3) e-/ h+ transport;
- (4) hole trapping;
- (5) Interface states build-up

- Fractional yield ( $f_E$ ) of holes depends on E-field in SiO<sub>2</sub> and track density (LET) produced by particle
- The same TID (Si) delivered by different radiation lead to different holes yield

M.R. Shaneyfelt et al. "Charge yield for Co-60 and 10keV X-ray irradiation", IEEE Trans.Nucl. Sci., **38**,1187, 1991

J.R.Schwank et al "Radiation effects in MOS oxides", IEEE Trans.Nucl.Sci., NS-55, 1833, 2008

F-Y.Su et al., IEEE Trans.on Nucl.Sci., 2022 (in press) DOI : 101109/TNS.2022.3153697

CENTRE FOR  
MEDICAL  
RADIATION  
PHYSICS



UNIVERSITY  
OF WOLLONGONG  
AUSTRALIA

# RadFET sensor for TID monitoring

## Threshold voltage shift:

1.  $\Delta V_{th}$  may be monitored *during* or *after* irradiation;
2. Bias on the gate during irradiation inhibits recombination of pairs; MOSFET response is linear with absorbed dose;
3. MOSFET sensitivity defined as:

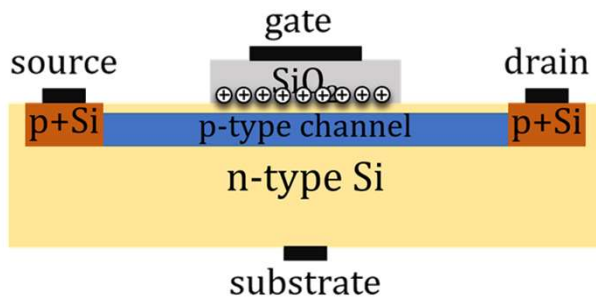

$$\Delta V_{th} \approx -\frac{qN_{ox}}{C_{ox}}$$

$$S \stackrel{\text{def}}{=} \frac{\Delta V_{th}}{D} \approx k_1 t_{ox}^2 f_E$$

$$k_1 = 39 \frac{\text{mV}}{\text{cGy } \mu\text{m}^2}$$

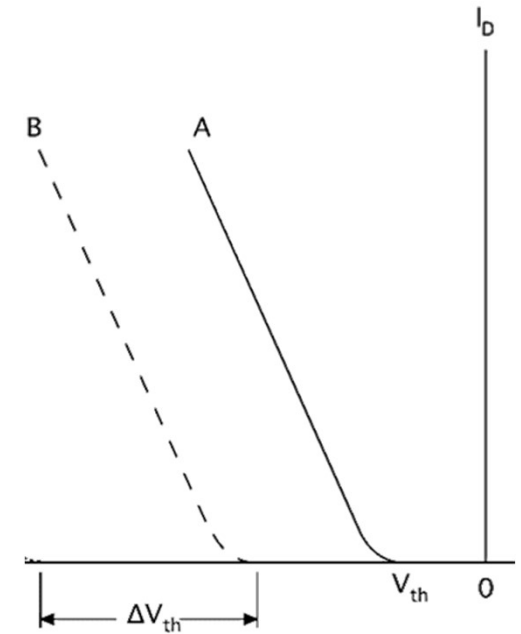

Taking into account for  $\text{SiO}_2$  :  
 $8.1 \times 10^{12}$  e-h pairs/cm<sup>3</sup> cGy(Si),  
 i.e. no e-h recombination.

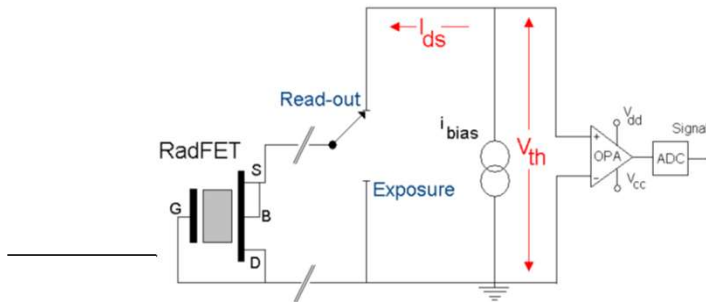

# MOSkin™ System Supply Chain

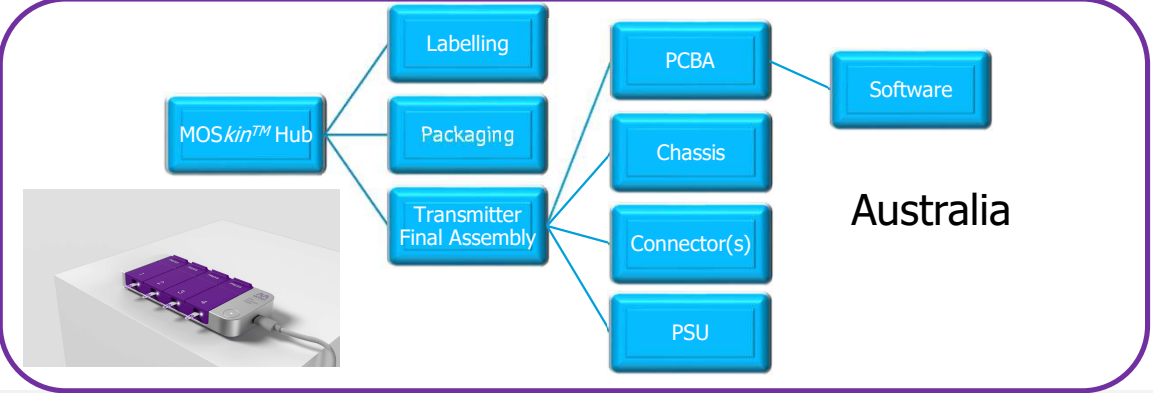
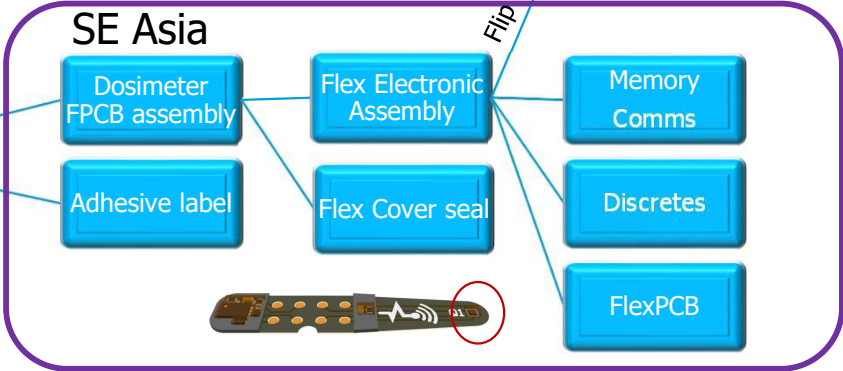
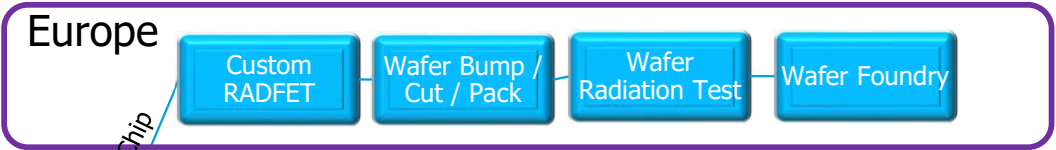
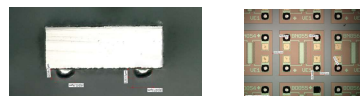



# MOSkin™ Testing

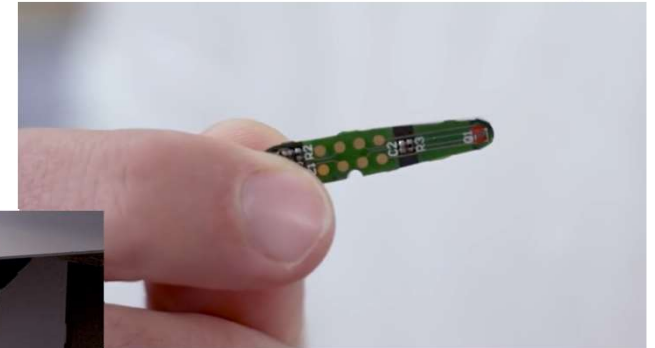



# MOSkin™ benefits

## Simple, fast, accurate dosimetry

- **Set up in minutes** by nurses or lab technicians. No need for additional specialist staff
- **Instant results** to support clinicians
- **Accurate measurement of all radiation tissue depths** including skin dose at Water Equivalent Depth (WED) of 0.07mm
- **Wireless data transfer** for real-time or passive mode
- **Radio-translucent** with no effect on radiation fields or visualisation
- **Low unit cost** , multi or single use – disposable

**Substantially simplifies the entire clinical pathway, at a fraction of the time and cost, with higher accuracy.**



- **Leads to improved Linac patient throughput**
- **Leads to improved patient safety & convenience**
- **ELL dosimeters are single use, requiring no disinfection**
- **Lower skill level staff are required to use and operate**
- **ELL dosimeter accuracy is higher than existing products**
- **Overall costs per use are substantially lower**
- **Results are delivered @ Linac, not laboratory hours later**
- **Leads to lower hospital labour and facility costs**

# Meeting clinical needs



Can be placed in more locations, offering **flexibility** in measurement of tumour and skin and surrounding tissue dose.

## In Linac Beam Applications

- On skin to confirm skin is receiving sufficient dose, especially in head & neck cancers
- On skin to confirm skin not receiving unacceptably high dose in head, neck and breast cancers
- On skin with a build-up hemisphere to check right dose at maximum Linac power, for all cancers
- At multiple skin locations during Total Body Irradiation / Total Skin Electron Therapy
- Placed intracavity (e.g.. nose) to confirm dose

## Out of Linac Beam Applications

- On eyelid with build-up to check eye lens not receiving unacceptably high dose during radiotherapy of head, neck, scalp & facial lesions
- Close to sensitive devices such as pacemaker/ implantable defibrillator to confirm device not receiving unacceptably high dose.

## Patient benefits

- ✓ **Reduced risk of overdosing** (skin burns, increased risk of secondary cancers)
- ✓ **Reduced risk of under dosing** (inadequate treatment and potential for recurrence).

# Multiple Revenue Models reduce market risk



## MOSkin™ Dosimeters



- Consumable
- 3 per patient on one session (fraction)
- Growth - Increase fractions
- Growth - Increase % patients

## MOSkin™ Hubs



- Capital Equipment
- 1 per LINAC
- Provide early revenue
- High margins

Diverse  
business  
and  
growth  
models

## MOSkin™ Software



- Annual license
- 1 per LINAC
- Annuity revenue stream
- Growth - Add functionality

## MOSkin™ Buildups



- Reusable
- 1 set per LINAC
- Access more use cases

# Platform Technology – collaboration with CMRP



Application across multiple medical radiation measurement applications

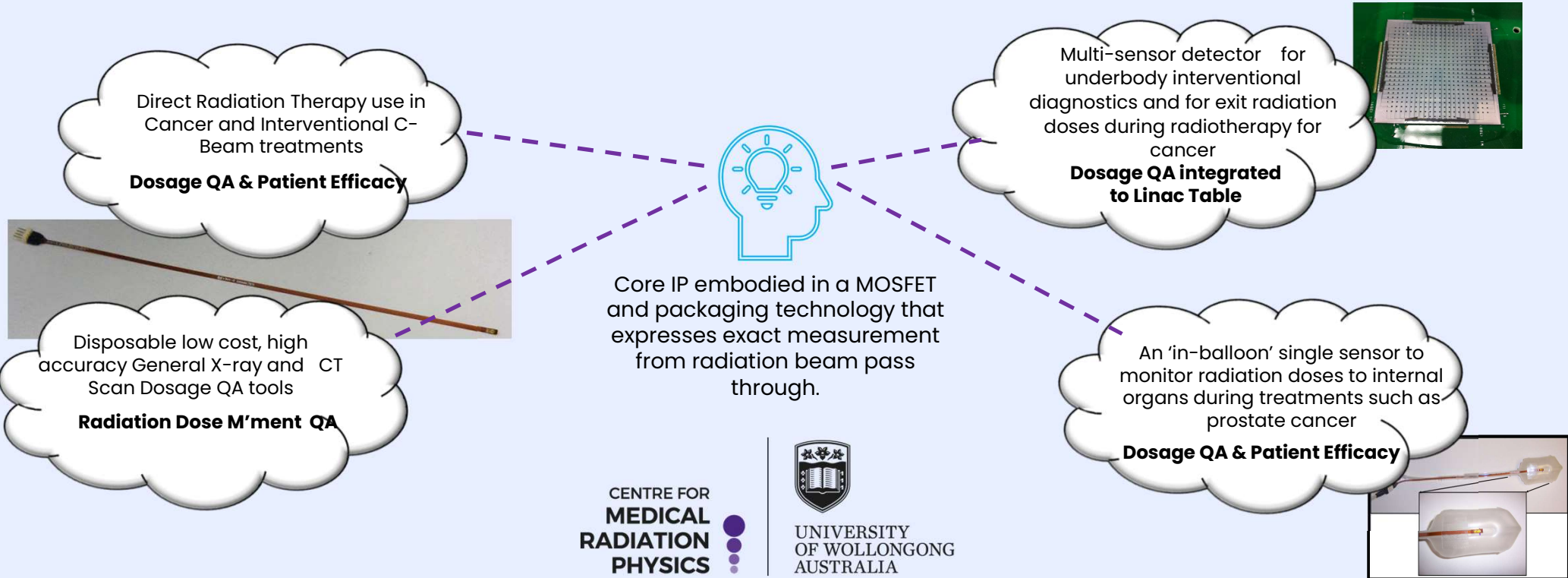

# Development Partners

CENTRE FOR  
**MEDICAL  
RADIATION  
PHYSICS**



UNIVERSITY  
OF WOLLONGONG  
AUSTRALIA

The Centre for Medical Radiation Physics is a research team within the School of Physics, University of Wollongong. Dedicated towards the development of semiconductor detectors and dosimeters for clinical applications in radiation protection, radiation oncology and nuclear medicine as well as high energy physics applications.

**GENESYS**  
ELECTRONICS DESIGN

Provides an ISO 13485:2016 certified electronic product and software development service from initial concept through to volume production.  
Industry-wide reputation for delivering high quality, state-of-the-art solutions that are commercially ready.



**Health**  
South Eastern Sydney  
Local Health District

St George Hospital Cancer Care Centre  
Radiation Oncology / Medical Physics  
Treatment planning and delivery of advanced radiotherapy including  
Intensity Modulated Radiation Therapy  
Stereotactic Body Radiation Therapy  
Stereotactic Radiosurgery  
Volumetric Modulated Radiation Therapy  
Brachytherapy

**D + I**  
Design + Industry

ISO 13485:2016 certified industrial design and product development consultancy, with over 50 industrial designers and mechanical engineers across Australia.

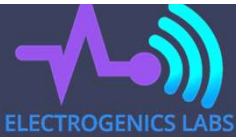

# MOSkin™

Patented MOSkin™ is the simple, fast, accurate answer for *in-vivo* radiation dosimetry

# Thank You

